

## 2 PIPELINE COMPONENTS

◀ home ▶



**QVF**  
PROCESS PLANT COMPONENTS



## Introduction

QVF borosilicate glass 3.3 pipeline is widely used in the chemical, pharmaceutical and allied industries together with other applications such as food and drink production, dye works and electroplating. This is because of the special properties of borosilicate glass 3.3 and PTFE (gaskets) plus the fact that borosilicate glass 3.3 is an approved and proven material of construction for pressure vessels.

Reference should also be made in this context to the extreme reliability of the improved, strong and high-duty coupling system used for all components. This is achieved throughout the whole range of nominal sizes by the use of the safety buttress end which has been designed specifically by taking into account the properties of the material combined with a reliable flange system.

The complete range of standard pipeline components is described on the following pages. Non-standard components can also be supplied to special order.

A detailed listing of all catalogue components by »Description« and »Reference« can be found in the »Index«.

Many of the components listed in this section are not only used in pipelines but also used in the design of process plant. For example pipe sections are used in columns, feed pipes are fitted in reducing tee pieces and reducers are also used as the top or bottom component in columns.



Detailed information on a number of the topics referred to in the following pages can be found in Section 1 »Technical Information«.

A deviation of up to 3° can be achieved by using the flexible gaskets described in Section 9 »Couplings« which considerably simplifies the design and installation of complicated pipeline systems.

Details of the design of the different types of optimised buttress ends are illustrated alongside.



DN15 - DN150



DN200 - DN300

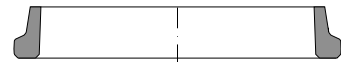

DN450 - DN1000

## Metric grid modular system

The pipeline components in the DN 15 to DN 150 nominal size range (pipe sections also up to DN 1000) described in this section comply with EN 12585 "Pipeline and Fittings, Compatibility and Interchangeability" and are conceived as a modular system. The only exception to this is the side branch on some reducing tee pieces. The basic unit of measurement is 25 mm and all component dimensions are a multiple of this basic length. The resultant metric grid system facilitates trouble-free design and installation of systems with these components.

In addition, all fittings and valves (please see Section 3 »Valves & Filters«) in the same nominal size always have the same limb length, so that bends can be interchanged with tee pieces or tee pieces with valves etc. This means that any modifications which may be required to existing pipelines can be carried out quickly and easily.

## GMP compliant installations

The layout of pipelines when designing plant and equipment complying with GMP regulations calls for special care in both the planning and selection of the components, together with the materials of construction used for them. Borosilicate glass 3.3 has a number of special properties that are highly valued in the pharmaceutical industry and these, in conjunction with PTFE materials (gaskets) approved in accordance with the FDA catalogue, ensure that any build-up of unwanted deposits is avoided in areas which come in contact with the product. A design without any dead space, which ensures that components drain fully and can be cleaned easily and effectively, is achieved by the shape of the components and the way they are installed. Where the external surfaces of the pipeline have to comply with clean room requirements, appropriate stainless steel coupling and support material can be supplied (please see Section 9 "Couplings" and Section 10 »Structures and Supports«).

We would be happy to advise you on the basis of the regulatory requirements applicable to a particular case and the guidelines drawn up by ourselves for the design of GMP compliant plant.

## Horizontally installed pipeline

Whereas vertical pipelines only have to support their own weight, bow can also occur in horizontal lines as a result of the additional weight of the liquids they contain. To reduce the resultant stress to a permissible level, supports should be provided at adequate intervals. The maximum spacing of these is indicated in Section 10 »Structures and Supports« as a function of the density  $\rho$  of the product being conveyed.

## Coated pipeline components

Damage to borosilicate glass 3.3 components resulting from accidental external causes cannot be entirely excluded, especially in the smaller nominal sizes. This is primarily due to the relatively rigorous conditions prevalent in production plants and applies especially where no additional protection is provided in the form of insulation.

Our answer to this problem is to provide borosilicate glass 3.3 pipeline components with a Sectrans transparent coating. This can be applied irrespective of the shape of the component and it provides additional protection without having any adverse effect on visual monitoring of the process.

A glass fibre reinforced polyester coating providing a higher level of protection can also be supplied on request. This does have a slightly adverse effect on the transparency of the glass, making it translucent and not transparent.

## Permissible operating conditions

While the maximum permissible operating temperature for all borosilicate glass 3.3 pipeline components is generally 200 °C ( $\Delta\theta \leq 180$  K), the maximum permissible operating pressure is governed by the main nominal size of the component but not by its shape. Detailed information on this and the operation of jacketed components can be found in Section 1 »Technical Information«.

The permissible operating conditions for components in other materials can be found in the respective product description.



Components suitable for higher permissible operating conditions can be supplied on request.

## The drainline piping system

For drainage, venting and dye lines, we recommend our beaded end borosilicate glass 3.3 drainline piping as an especially economical solution. All components can be used up to a maximum permissible operating pressure of 0.5 bar g.

Detailed information on this and the complete product range can be found in a separate brochure.

## PIPE SECTIONS

Pipe sections are used not only in pipeline systems but also in the design of columns.

For example, pipe sections with »LBE...« type packing supports (please see Section 6 »Column Components«) clamped between the ends provide a larger free cross-section than the combination of column section and built-in packing support. Increased packed heights can be achieved by installing a pipe section on top of a column section.

 Precision bore pipe sections with tight tolerances for chromatography columns and special column internals are listed in Section 6 »Column Components«.

The end form, which depends on the nominal size, is shown in the diagram on page 2.2. Further information can be found in Section 1 »Technical Information«.

	Reference	Reference	Reference	Reference
L	DN15	DN25	DN 40	DN50
75	PS15/75	PS25/75	-	-
100	PS15/100	PS25/100	PS40/100	PS50/100
125	PS15/125	PS25/125	PS40/125	PS50/125
150	PS15/150	PS25/150	PS40/150	PS50/150
175	PS15/175	PS25/175	PS40/175	PS50/175
200	PS15/200	PS25/200	PS40/200	PS50/200
300	PS15/300	PS25/300	PS40/300	PS50/300
400	PS15/400	PS25/400	PS40/400	PS50/400
500	PS15/500	PS25/500	PS40/500	PS50/500
700	PS15/700	PS25/700	PS40/700	PS50/700
1000	PS15/1000	PS25/1000	PS40/1000	PS50/1000
1500	PS15/1500	PS25/1500	PS40/1500	PS50/1500
2000	PS15/2000	PS25/2000	PS40/2000	PS50/2000
3000	-	PS25/3000	PS40/3000	PS50/3000

	Reference	Reference	Reference
L	DN80	DN100	DN150
125	PS80/125	-	-
150	PS80/150	PS100/150	PS150/150
175	PS80/175	PS100/175	PS150/175
200	PS80/200	PS100/200	PS150/200
300	PS80/300	PS100/300	PS150/300
400	PS80/400	PS100/400	PS150/400
500	PS80/500	PS100/500	PS150/500
700	PS80/700	PS100/700	PS150/700
1000	PS80/1000	PS100/1000	PS150/1000
1500	PS80/1500	PS100/1500	PS150/1500
2000	PS80/2000	PS100/2000	PS150/2000
3000	PS80/3000	PS100/3000	PS150/3000

	Reference	Reference	Reference
L	DN200	DN300	DN450
300	PS200/300	PS300/300	-
500	PS200/500	PS300/500	PSN450/500
1000	PS200/1000	PS300/1000	PSN450/1000
1500	PS200/1500	PS300/1500	PSN450/1500
2000	PS200/2000	PS300/2000	PSN450/2000

	Reference	Reference	Reference
L	DN600	DN800	DN1000
500	PSN600/500	-	-
1000	PSN600/1000	PS800/1000	PS1000/1000
1500	PSN600/1500	PS800/1500	PS1000/1500

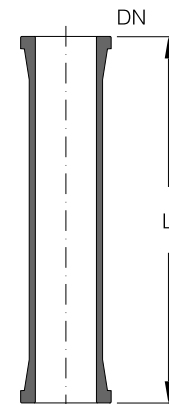

DN15 - DN300

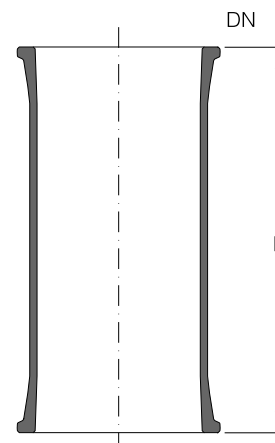

DN450 - DN1000

## SPACERS

Variations in length can be accommodated by having pipe sections specially made to the appropriate length. A simple alternative is, however, to use spacers. These are fitted between the ends of the adjacent components using an additional gasket and bolts of the appropriate length.

L	Type	Reference	Reference	Reference	Reference
		DN15	DN25	DN40	DN50
10	A	SS15/10	SS25/10	SS40/10	SS50/10
15	A	SS15/15	SS25/15	SS40/15	SS50/15
20	A	SS15/20	SS25/20	SS40/20	SS50/20
25	A	SS15/25	SS25/25	SS40/25	SS50/25
50	C	PSS15/50	-	-	-
50	B	-	PSS25/50	PSS40/50	PSS50/50
75	B	-	-	PSS40/75	PSS50/75

L	Type	Reference	Reference	Reference
		DN80	DN100	DN150
10	A	SS80/10	SS100/10	SS150/10
15	A	SS80/15	SS100/15	SS150/15
20	A	SS80/20	SS100/20	SS150/20
25	A	SS80/25	SS100/25	SS150/25
50	B	PSS80/50	PSS100/50	PSS150/50
75	B	PSS80/75	PSS100/75	PSS150/75
100	C	PSS80/100	-	-
100	B	-	PSS100/100	PSS150/100
125	C	-	PSS100/125	PSS150/125

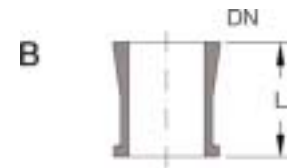
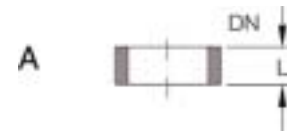

## ADAPTORS-PTFE

These components can be used up to a maximum operating temperature of 130 °C. They carry out parallel duties: they provide a trouble-free method of connecting components with safety buttress ends to the KF system and they also act as gaskets. Adaptors should always be installed with the location collar on the safety buttress end.

The KF buttress end requires a different type of coupling. For further information please contact our Sales Department.



The borosilicate glass 3.3 adaptors described on page 2.6 supplement these PTFE adaptors for larger nominal sizes and higher operating temperature.

DN	L	Reference
15	6	KRT15
25	7	KRT25
40	8	KRT40
50	8	KRT50
80	10	KRT80

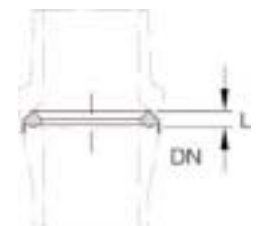
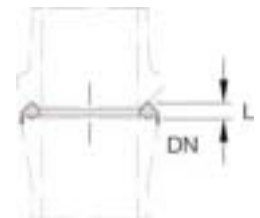

## ADAPTORS-GLASS

In the larger nominal sizes and at higher operating temperatures, when the »KRT.« adaptors described on page 2.5 cannot be used, »AMS.« or »AFS.« adaptors made of borosilicate glass 3.3 should be used.

Couplings for the safety buttress end of the adaptors can be found in Section 9 »Couplings«. The KF buttress end requires a different type of coupling. For further information please contact our Sales Department.

DN	L	Reference	Reference
		Type A	Type B
15	75	AMS15	AFS15
25	75	AMS25	AFS25
40	100	AMS40	AFS40
50	100	AMS50	AFS50
80	125	AMS80	AFS80
100	150	AMS100	AFS100
150	150	AMS150	AFS150
200	150	AMS200	AFS200
300	200	AMS300	AFS300

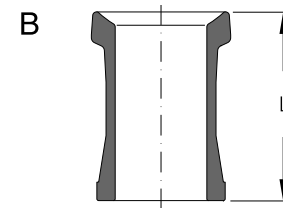
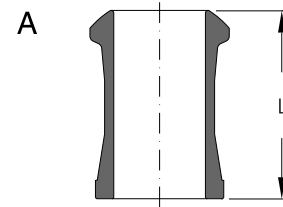

## REDUCERS

There are both concentric and eccentric versions of these components available to comply with the varying requirements encountered in practice. In DN 150 nominal size and above the basic form of these components is hemispherical.

The concentric version should always be used for preference in vertical installations.

Eccentric reducers are very frequently used in horizontal pipelines where there is a change of bore to enable them to drain completely. There can also be a requirement for this version for design reasons, e.g. where there is a change of lateral alignment.



The end form, which depends on the nominal size, is shown in the diagram on page 2.2. Further information can be found in Section 1 »Technical Information«.

## REDUCERS

### Concentric Reducers

DN	DN1	L	Reference
25	15	100	PR25/15
40	15	100	PR40/15
40	25	100	PR40/25
50	15	100	PR50/15
50	25	100	PR50/25
50	40	100	PR50/40
80	25	125	PR80/25
80	40	125	PR80/40
80	50	125	PR80/50
100	25	150	PR100/25
100	40	150	PR100/40
100	50	150	PR100/50
100	80	150	PR100/80
150	25	200	PR150/25
150	40	200	PR150/40
150	50	200	PR150/50
150	80	200	PR150/80
150	100	200	PR150/100
200	25	175	PR200/25
200	40	175	PR200/40
200	50	175	PR200/50
200	80	200	PR200/80
200	100	200	PR200/100
200	150	200	PR200/150
300	25	225	PR300/25
300	40	225	PR300/40
300	50	225	PR300/50
300	80	250	PR300/80
300	100	250	PR300/100
300	150	275	PR300/150
300	200	250	PR300/200
450	50	325	PR450/50
450	80	325	PR450/80
450	100	350	PR450/100
450	150	350	PR450/150
450	200	325	PR450/200
450	300	325	PR450/300
600	50	375	PR600/50
600	80	375	PR600/80
600	100	400	PR600/100
600	150	425	PR600/150
600	200	400	PR600/200
600	300	400	PR600/300
800	80	550	PR800/80
800	100	550	PR800/100
800	150	575	PR800/150
800	200	550	PR800/200
800	300	550	PR800/300
1000	300	650	PR1000/300
1000	450	650	PRN1000/450
1000	600	650	PRN1000/600

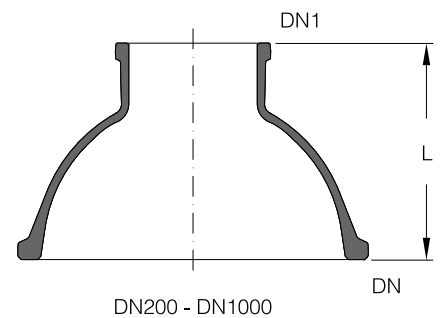
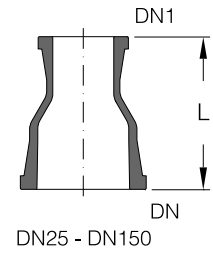

## REDUCERS

### Eccentric Reducers

DN	DN1	L	L1	Reference
25	15	100	5	PRE25/15
40	25	100	6	PRE40/25
50	25	100	12	PRE50/25
50	40	100	6	PRE50/40
80	25	125	24	PRE80/25
80	40	125	18	PRE80/40
80	50	125	12	PRE80/50
100	25	150	39	PRE100/25
100	40	150	33	PRE100/40
100	50	150	27	PRE100/50
100	80	150	15	PRE100/80
150	50	200	52	PRE150/50
150	80	200	40	PRE150/80
150	100	200	25	PRE150/100

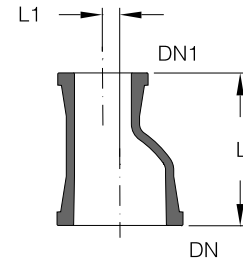

## 90° BEND REDUCERS

These items are an alternative to using a reducer plus a 90° bend. This saves one gasket and coupling and also reduces the overall length required.

 The end form, which depends on the nominal size, is shown in the diagram on page 2.2. Further information can be found in Section 1 »Technical Information«.

DN	DN1	L	L1	Reference
40	25	125	100	PBR40/25
50	40	150	150	PBR50/40
80	50	150	150	PBR80/50
100	50	200	150	PBR100/50
100	80	200	175	PBR100/80
150	50	200	150	PBR150/50
150	80	250	175	PBR150/80
200	80	250	175	PBR200/80
300	80	300	175	PBR300/80
300	150	350	250	PBR300/150

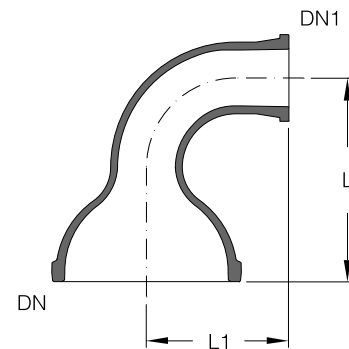



## BENDS

Bends are available in a variety of angles to suit different applications. This applies, for example, to 10° and 80° bends whose uses include connections to reflux dividers (please see Section 6 »Column Components«) and thin film evaporators.

Bends up to and including DN 150 nominal size are supplied as "swept bends", and in the larger nominal sizes "mitred bends".



In addition to the standard range specified below, bends of other angles and in larger nominal sizes can also be supplied on request.

Bends with thermometer branch can be found on page 2.11.

The end form, which depends on the nominal size, is shown in the diagram on page 2.2. Further information can be found in Section 1 »Technical Information«.

## BENDS

### 90° Bends

DN	L	Reference
15	50	PB90/15
25	100	PB90/25
40	150	PB90/40
50	150	PB90/50
80	200	PB90/80
100	250	PB90/100
150	250	PB90/150
200	300	PB90/200
300	400	PB90/300

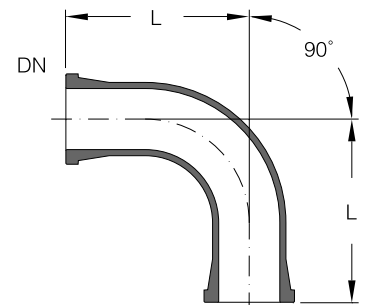

DN15 - DN150

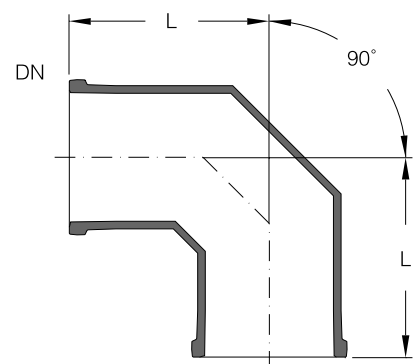

DN200 - DN300

## BENDS

### 80° Bends

DN	L	Reference
25	100	PB80/25
40	150	PB80/40
50	150	PB80/50
80	200	PB80/80
100	250	PB80/100
150	250	PB80/150

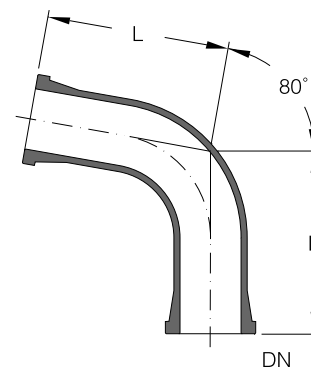

## BENDS

### 45° Bends

DN	L	Reference
15	50	PB45/15
25	75	PB45/25
40	100	PB45/40
50	100	PB45/50
80	125	PB45/80
100	175	PB45/100
150	200	PB45/150
200	200	PB45/200
300	200	PB45/300

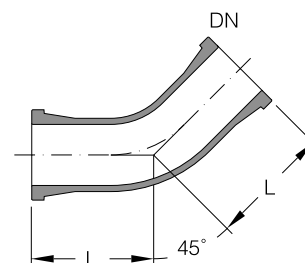

DN15 - DN150

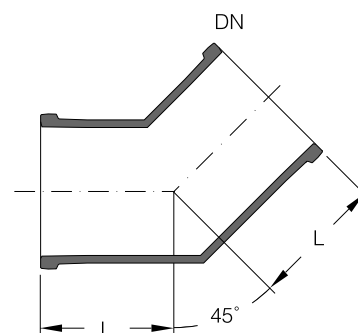

DN200 - DN300

## BENDS

### 10° Bends

DN	L	Reference
25	50	PB10/25
40	75	PB10/40
50	100	PB10/50
80	125	PB10/80
100	150	PB10/100

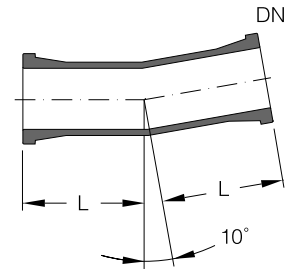

## 90° BENDS WITH THERMOMETER BRANCH

This is a version of the 90° bend that allows a thermometer or measuring probe to be inserted axially into a line (please see Section 8 »Measurement & Control«).

 The end form, which depends on the nominal size, is shown in the diagram on page 2.2. Further information can be found in Section 1 »Technical Information«.

DN	DN1	L	L1	Reference
50	25	150	225	PBT50
80	25	200	280	PBT80
100	25	250	330	PBT100
150	25	250	340	PBT150
200	25	300	450	PBT200
300	25	400	525	PBT300

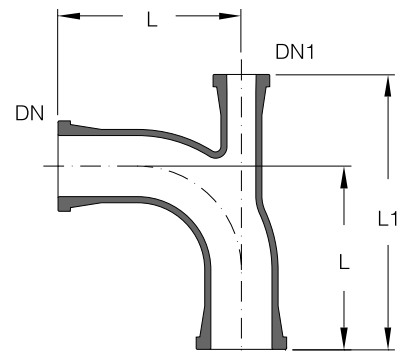

DN50 - DN150

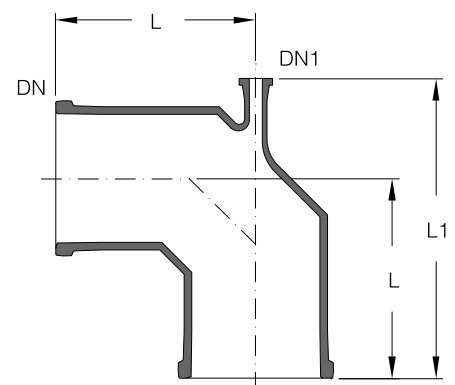

DN200 - DN300

## U BENDS

These components are used to turn a pipeline through 180° without the need for any other horizontal or vertical components.

DN	L	L1	Reference
15	75	75	PU15
25	140	140	PU25
40	180	180	PU40
50	180	180	PU50
80	200	230	PU80

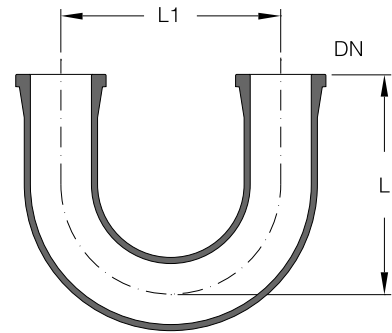

## U BENDS WITH BOTTOM OUTLET

Typical applications for U bends with bottom outlet include merging two different flow streams in a pipeline system, provision of a vented overflow on columns and liquid seals with drain.

DN	L	L1	Reference
15	125	75	PUO15
25	210	140	PUO25
40	270	180	PUO40
50	280	180	PUO50

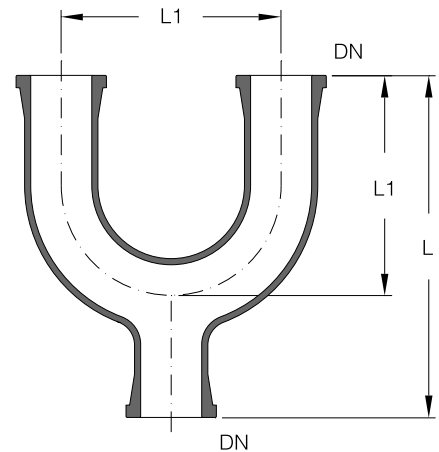

## CROSS PIECES

Cross pieces are important components in complex systems of interconnecting pipeline.

DN	L	Reference
15	50	PX15
25	100	PX25
40	150	PX40
50	150	PX50
80	200	PX80
100	250	PX100
150	250	PX150

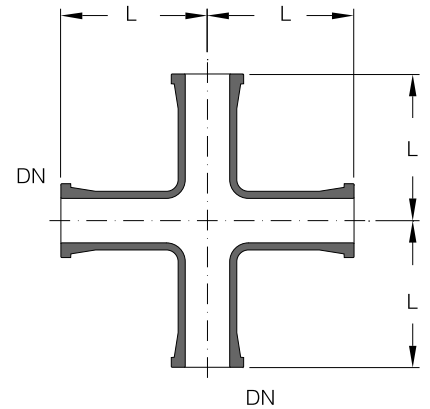

## EQUAL TEE PIECES

Equal tee pieces are used for junctions in pipelines of the same nominal size. They have the same limb length as 90° bends.

 The end form, which depends on the nominal size, is shown in the diagram on page 2.2. Further information can be found in Section 1 »Technical Information«.

DN	L	Reference
15	50	PT15
25	100	PT25
40	150	PT40
50	150	PT50
80	200	PT80
100	250	PT100
150	250	PT150
200	300	PT200
300	400	PT300

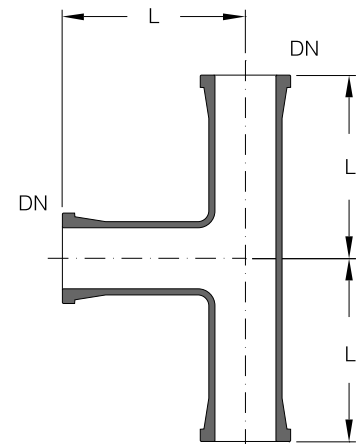

## UNEQUAL TEE PIECES

Unequal tee pieces are mainly used in the design of columns and at junctions between pipelines of different nominal sizes.

In addition to the standard range specified below, unequal tee pieces can also be supplied with other nominal size side branches on request.



The end form, which depends on the nominal size, is shown in the diagram on page 2.2. Further information can be found in Section 1 »Technical Information«.

DN	DN1	L	L1	Reference
25	15	150	75	PTU25/15
40	25	200	75	PTU40/25
50	25	200	80	PTU50/25
50	40	200	100	PTU50/40
80	25	250	100	PTU80/25
80	40	250	100	PTU80/40
80	50	250	115	PTU80/50
100	25	250	110	PTU100/25
100	40	250	125	PTU100/40
100	50	250	125	PTU100/50
100	80	300	150	PTU100/80
150	25	250	150	PTU150/25
150	40	250	150	PTU150/40
150	50	250	150	PTU150/50
150	80	300	175	PTU150/80
150	100	300	200	PTU150/100
200	40	250	175	PTU200/40
200	50	250	175	PTU200/50
200	80	300	200	PTU200/80
200	100	300	225	PTU200/100
200	150	400	250	PTU200/150
300	40	400	225	PTU300/40
300	50	400	225	PTU300/50
300	80	400	240	PTU300/80
300	100	400	275	PTU300/100
300	150	500	300	PTU300/150
300	200	600	275	PTU300/200
450	80	400	325	PTU450/80
450	150	500	375	PTU450/150
600	150	600	450	PTU600/150
600	300	800	500	PTU600/300
800	150	700	575	PTU800/150
800	300	1000	650	PTU800/300
1000	150	700	675	PTU1000/150
1000	300	1000	750	PTU1000/300

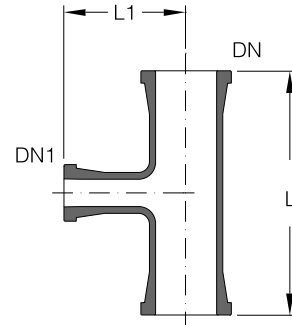

DN25 - DN300

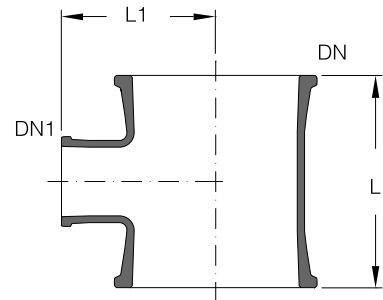

DN450 - DN1000

## Y PIECES

These components are used in a similar way to U bends with a bottom outlet for merging two different flow streams in a pipeline system and also for incorporating measuring probes in vertical pipelines.

DN	DN1	L	L1	L2	Type	Reference
15	-	125	70	5	A	PY15
25	-	200	106	19	A	PY25
40	25	225	92	83	B	PY40/25
40	-	250	124	26	A	PY40
50	25	250	99	101	B	PY50/25
50	-	300	141	33	A	PY50
80	-	350	177	23	A	PY80
100	-	450	247	52	A	PY100

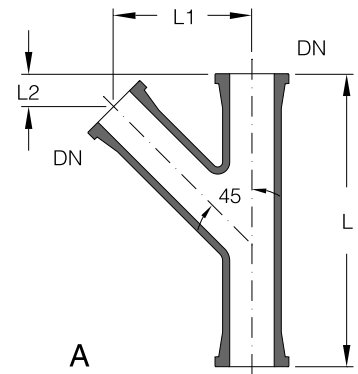

A

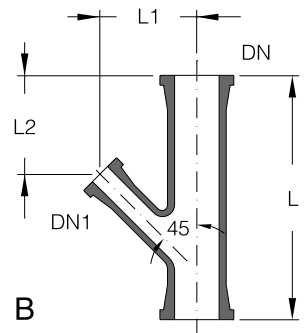

B

## CLOSURES

Where branches have to be closed off, closures should be used together with a standard coupling. If frequent access to a branch is required, a quick release coupling should be used instead (please see Section 9 »Couplings«).

In nominal size DN 200 and above, closures are supplied in the hemispherical end version.



The end form, which depends on the nominal size, is shown in the diagram on page 2.2. Further information can be found in Section 1 »Technical Information«.

DN	L	Reference
15	40	PBE15
25	75	PBE25
40	75	PBE40
50	100	PBE50
80	95	PBE80
100	145	PBE100
150	125	PBE150
200	120	PBE200
300	170	PBE300

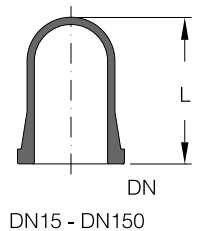

DN15 - DN150

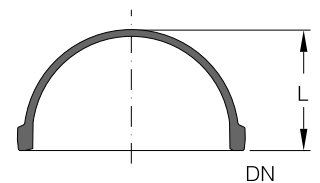

DN200 - DN300

## HOSE CONNECTORS

Hose connectors are used to connect flexible lines (hoses) for such purposes as to drain a unit, to carry cooling water to and from heat exchangers or for heating jacketed components. The internal diameter of the hoses should be as indicated in the table below to avoid fixing and leakage problems.



In the case of long and/or heavy hoses, 90° hose connectors should be used to reduce the bending moment on the connecting branches.

## HOSE CONNECTORS

### Straight Hose Connectors

DN	hose-iØ d	L	Reference
15	10	70	PHC15/10
15	13	70	PHC15/13
15	16	110	PHC15/16
15	18	70	PHC15/18
15	20	70	PHC15/20
25	20	90	PHC25/20
25	26	110	PHC25/26
40	26	100	PHC40/26
40	42	110	PHC40/42

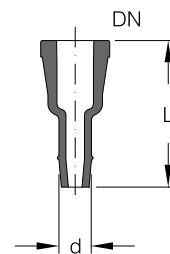



## HOSE CONNECTORS

### 90° Hose Connectors

DN	hose-iØ d	L	L1	Reference
15	16	60	60	<a href="#">PHC90/15/16</a>
15	18	60	60	<a href="#">PHC90/15/18</a>
15	20	60	60	<a href="#">PHC90/15/20</a>
25	20	60	80	<a href="#">PHC90/25/20</a>
25	26	70	80	<a href="#">PHC90/25/26</a>

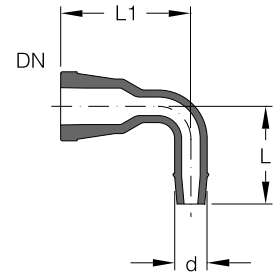

## METAL HOSE CONNECTORS

The use of these hose connectors, manufactured from stainless steel, is recommended where there is a requirement for connecting flexible hoses containing heat transfer fluids at elevated temperatures to jacketed components, or long and/or heavy hoses containing coolant to heat exchangers.

Metal hose connectors are supplied complete with the flange, insert, gasket and fastenings necessary to connect to the glass branch in question.

DN	hose-iØ d	L	L1	Reference
15	13	50	10	<a href="#">PMC15/13</a>
25	20	70	15	<a href="#">PMC25/20</a>
50	42	90	40	<a href="#">PMC50/42</a>

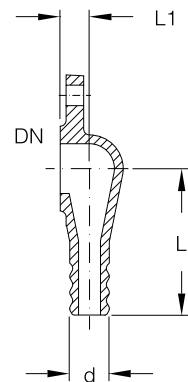

## JACKETED COMPONENTS

Jacketed components provide a means of heating and cooling pipeline systems. Jacketed versions of pipe sections, bends and tee pieces are available as standard components up to DN 80 inclusive. In the case of fittings and shorter pipe sections (up to L = 500 mm) the jacket is one-piece and welded at both ends. On longer pipe sections, because of differences in linear expansion between the inner component and the jacket, we incorporate a split design with a flexible seal.

In addition to the standard components listed below, pipe sections of other lengths and larger nominal sizes (up to DN 300 ) together with fittings up to DN 150 are also available.



The permissible operating conditions for the jacket and inner component can be found in Section 1 "Technical Information".

The branches on the jacket are of the QVF safety buttress end type. If they are aligned horizontally with long or heavy hoses connected to them, we recommend 90° hose connectors to reduce the bending moment on the branches.

Borosilicate glass 3.3 and metal hose connectors can be found on pages 2.16 and 2.17 and hoses in Section 9 »Couplings«.

Components can also be supplied on request with jackets extending up to the buttress end. Further details of these can be found in Section 1 »Technical Information«.

## JACKETED COMPONENTS

### Pipe Sections

DN	DN1	L	L1	L2	Type	Reference
15	15	200	50	65	A	DPS15/200
15	15	300	50	65	A	DPS15/300
15	15	400	50	65	A	DPS15/400
15	15	500	50	65	A	DPS15/500
15	15	700	50	65	B	DPS15/700
15	15	1000	50	65	B	DPS15/1000
15	15	1500	50	65	B	DPS15/1500
15	15	2000	50	65	B	DPS15/2000
25	15	200	65	75	A	DPS25/200
25	15	300	65	75	A	DPS25/300
25	15	400	65	75	A	DPS25/400
25	15	500	65	75	A	DPS25/500
25	15	700	65	75	B	DPS25/700
25	15	1000	65	75	B	DPS25/1000
25	15	1500	65	75	B	DPS25/1500
25	15	2000	65	75	B	DPS25/2000
40	15	300	65	80	A	DPS40/300
40	15	400	65	80	A	DPS40/400
40	15	500	65	80	A	DPS40/500
40	15	700	65	80	B	DPS40/700
40	15	1000	65	80	B	DPS40/1000
40	15	1500	65	80	B	DPS40/1500
40	15	2000	65	80	B	DPS40/2000
50	15	300	70	85	A	DPS50/300
50	15	400	70	85	A	DPS50/400
50	15	500	70	85	A	DPS50/500
50	15	700	70	85	B	DPS50/700
50	15	1000	70	85	B	DPS50/1000
50	15	1500	70	85	B	DPS50/1500
50	15	2000	70	85	B	DPS50/2000
80	15	300	90	100	A	DPS80/300
80	15	400	90	100	A	DPS80/400
80	15	500	90	100	A	DPS80/500
80	15	700	90	100	B	DPS80/700
80	15	1000	90	100	B	DPS80/1000
80	15	1500	90	100	B	DPS80/1500
80	15	2000	90	100	B	DPS80/2000

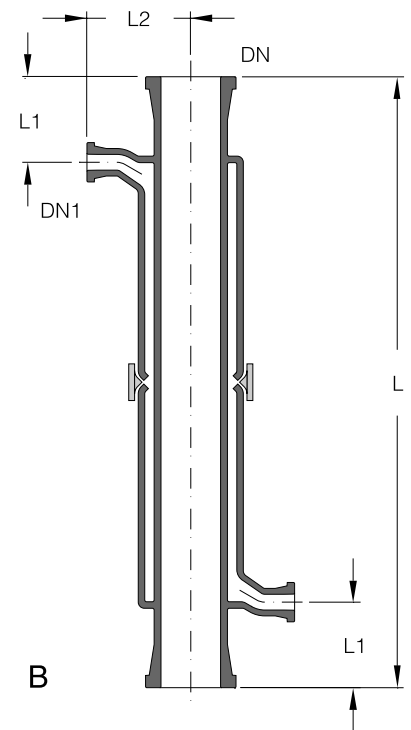
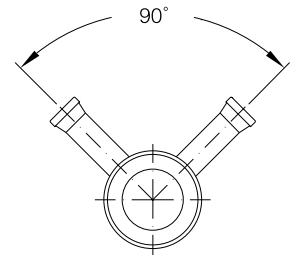
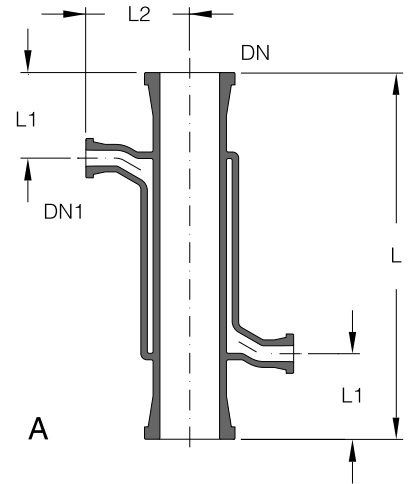

## JACKETED COMPONENTS

### 90° Bends

DN	DN1	L	L1	L2	Reference
15	15	75	50	60	DPB90/15
25	15	100	65	70	DPB90/25
40	15	150	65	75	DPB90/40
50	15	150	70	80	DPB90/50
80	15	200	90	95	DPB90/80

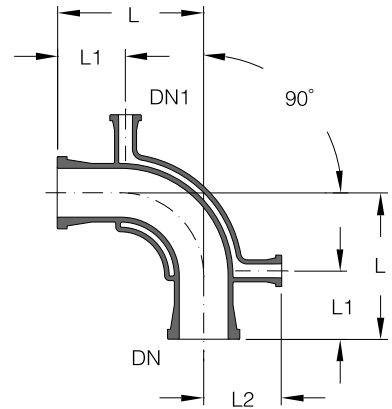

## JACKETED COMPONENTS

### 45° Bends

DN	DN1	L	L1	L2	Reference
15	15	75	50	60	DPB45/15
25	15	100	65	70	DPB45/25
40	15	100	65	75	DPB45/40
50	15	100	70	80	DPB45/50
80	15	125	90	95	DPB45/80

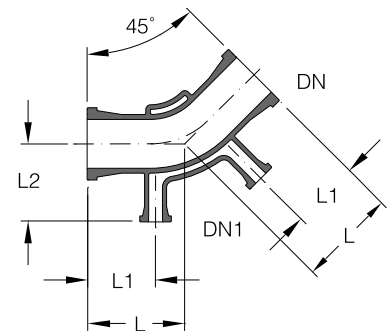

## JACKETED COMPONENTS

### Tee Pieces

DN	DN1	L	L1	L2	Reference
25	15	100	65	75	DPT25
40	15	150	65	80	DPT40
50	15	150	70	85	DPT50
80	15	200	90	100	DPT80

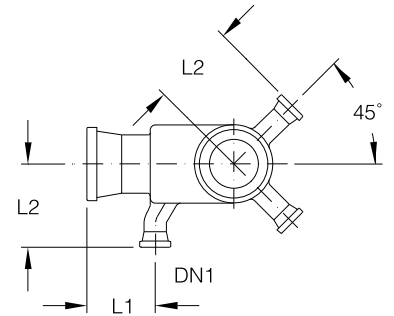
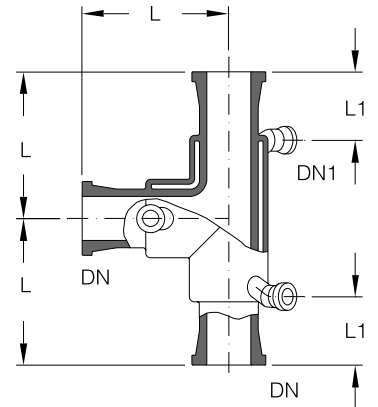

## JACKETED COMPONENTS

### Unequal Tee Pieces

DN	DN1	DN2	L	L1	L2	L3	L4	Reference
25	15	15	100	65	75	65	50	DPTU25/15
40	25	15	100	65	80	75	65	DPTU40/25
50	25	15	125	70	85	75	65	DPTU50/25
50	40	15	125	70	85	75	65	DPTU50/40
80	25	15	150	90	100	75	65	DPTU80/25
80	40	15	150	90	100	80	65	DPTU80/40
80	50	15	150	90	100	85	70	DPTU80/50

